

Wood Trick[®]
A NEW WORLD OF ART

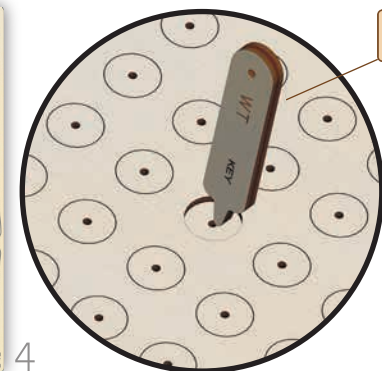

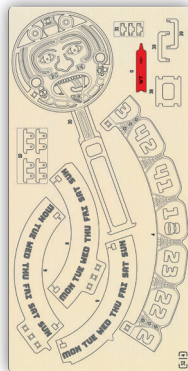

0

4

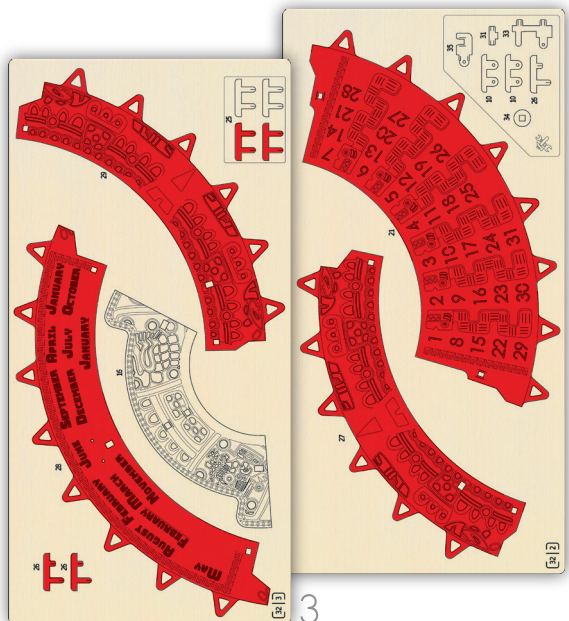

2

3

28

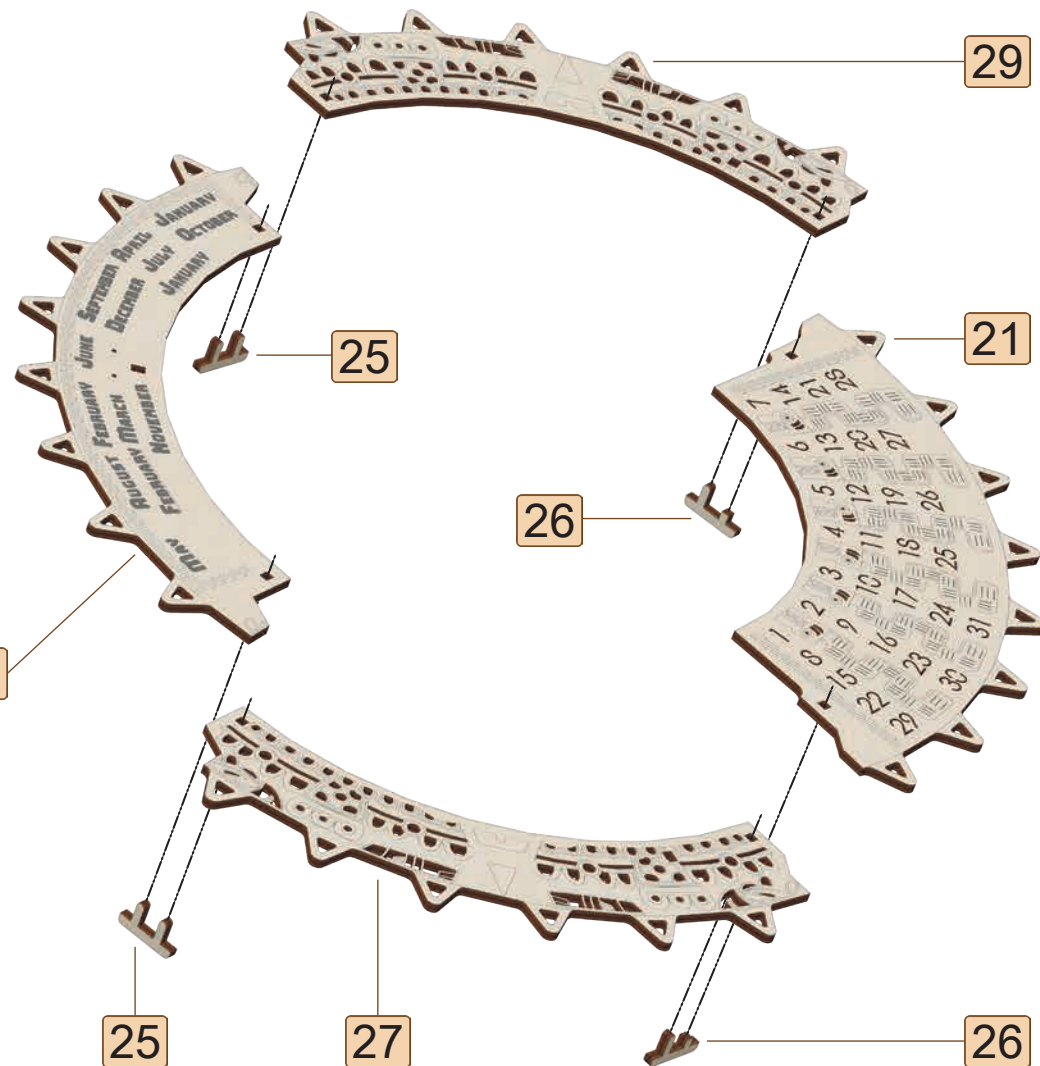

29

21

26

25

25

27

26



[1]

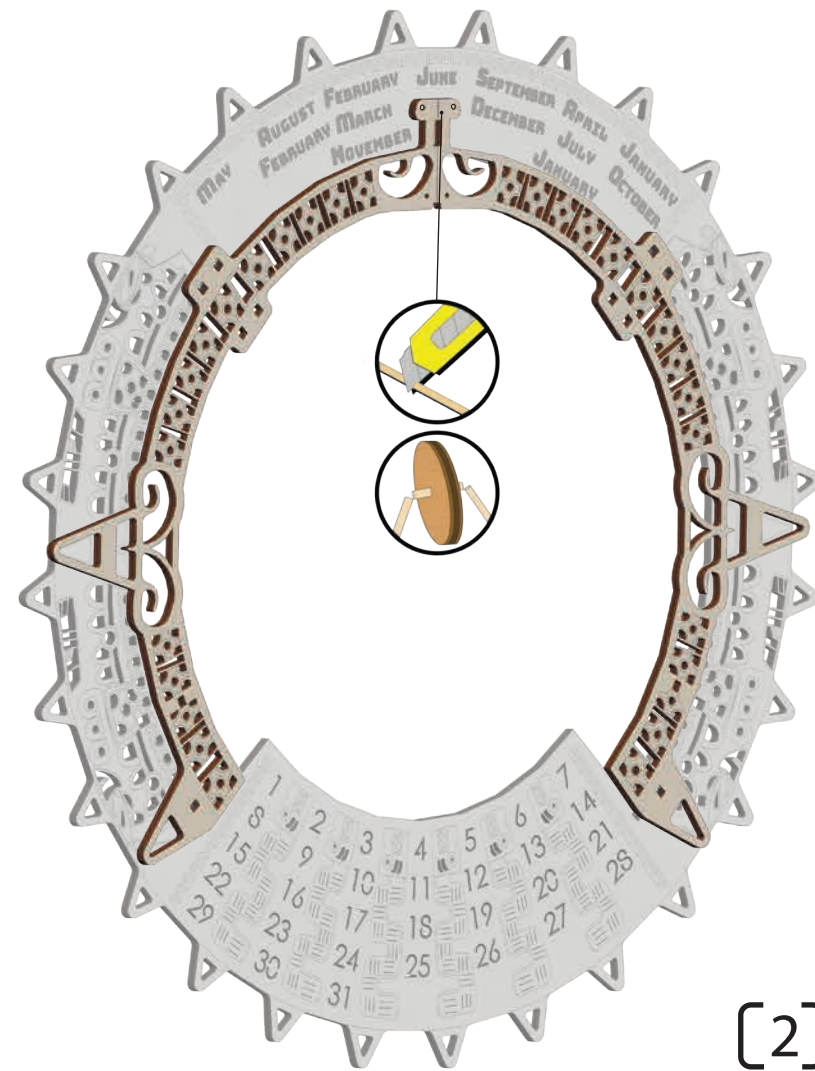
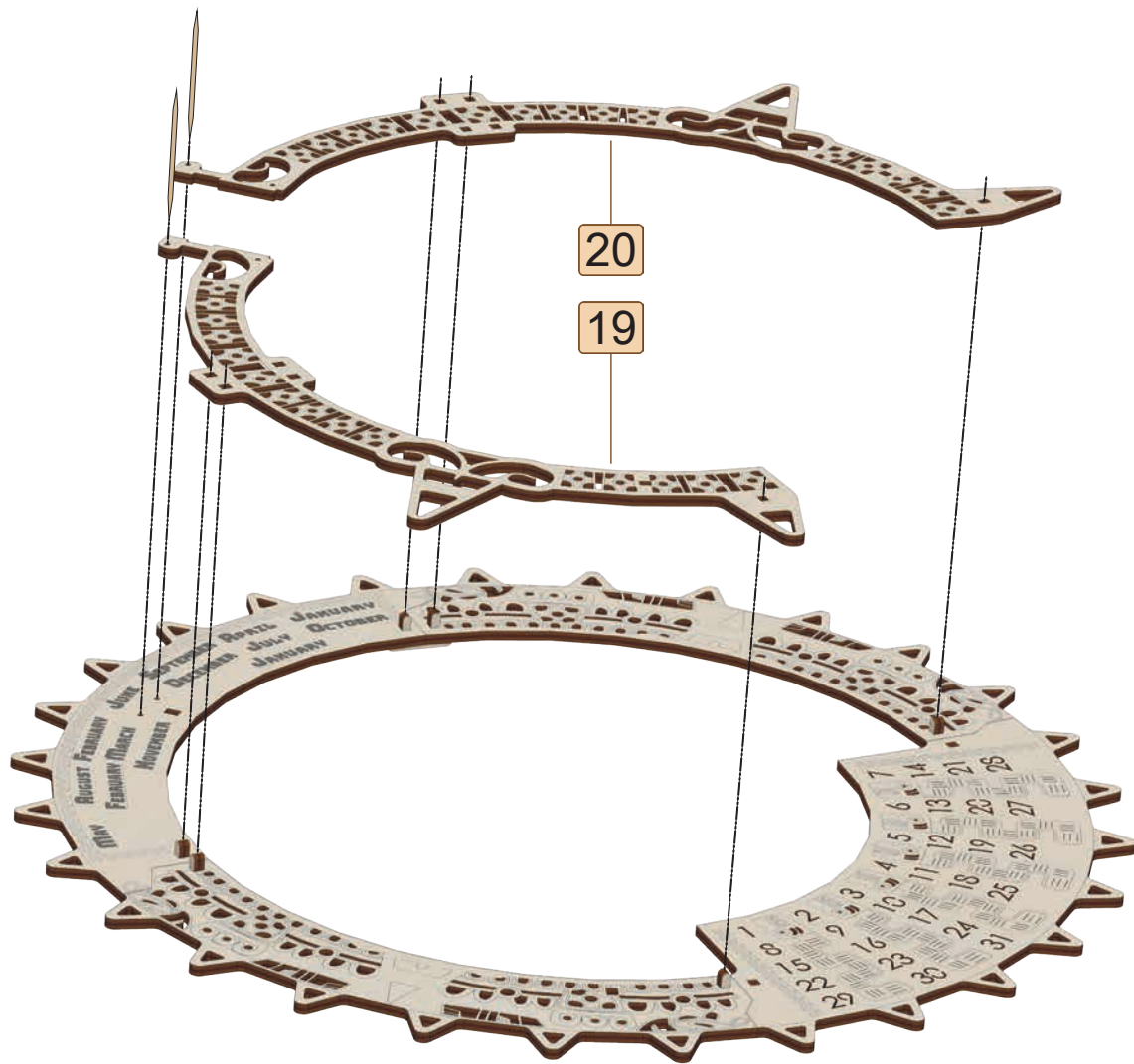
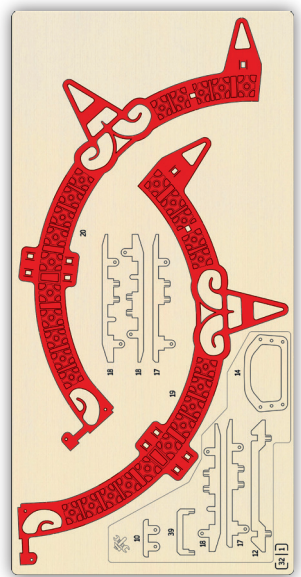

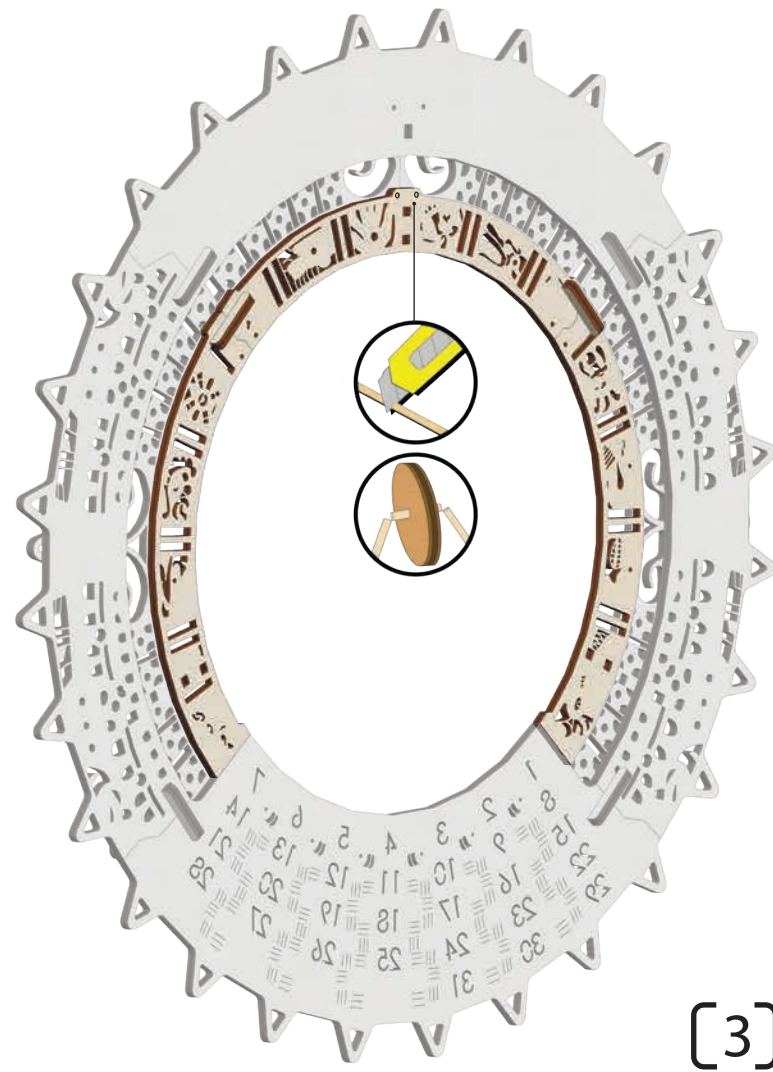
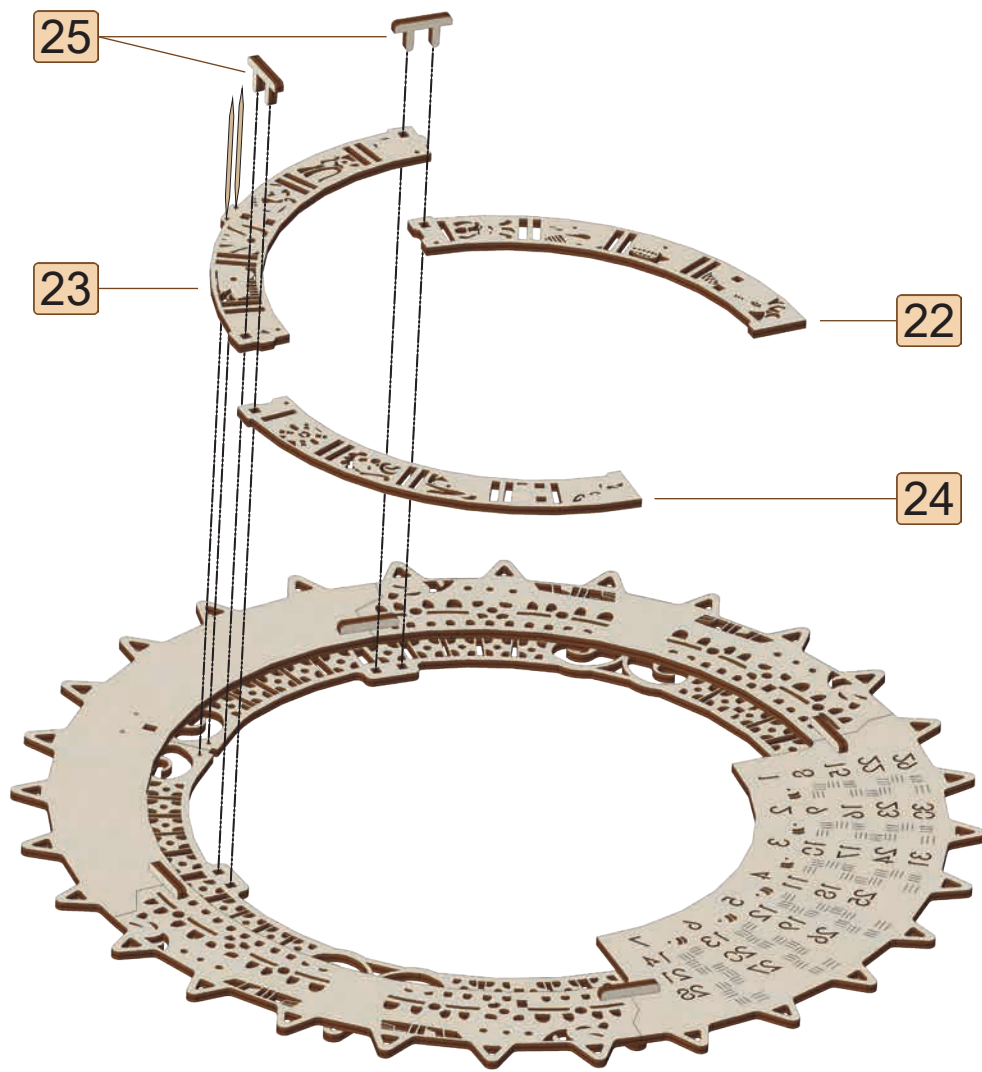
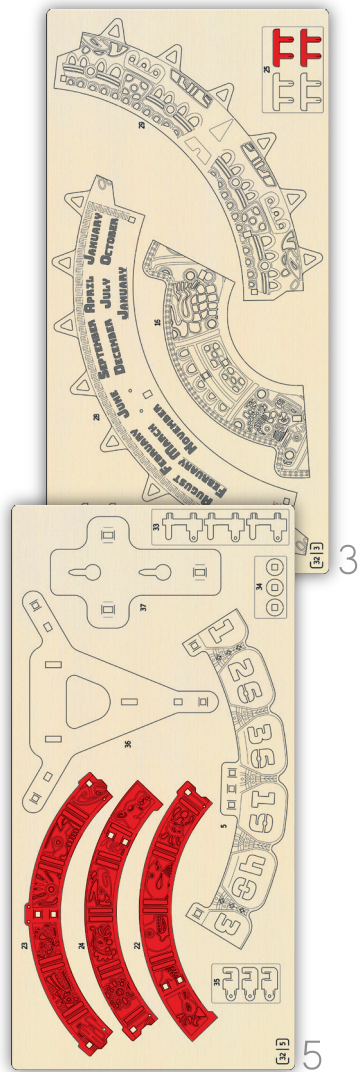

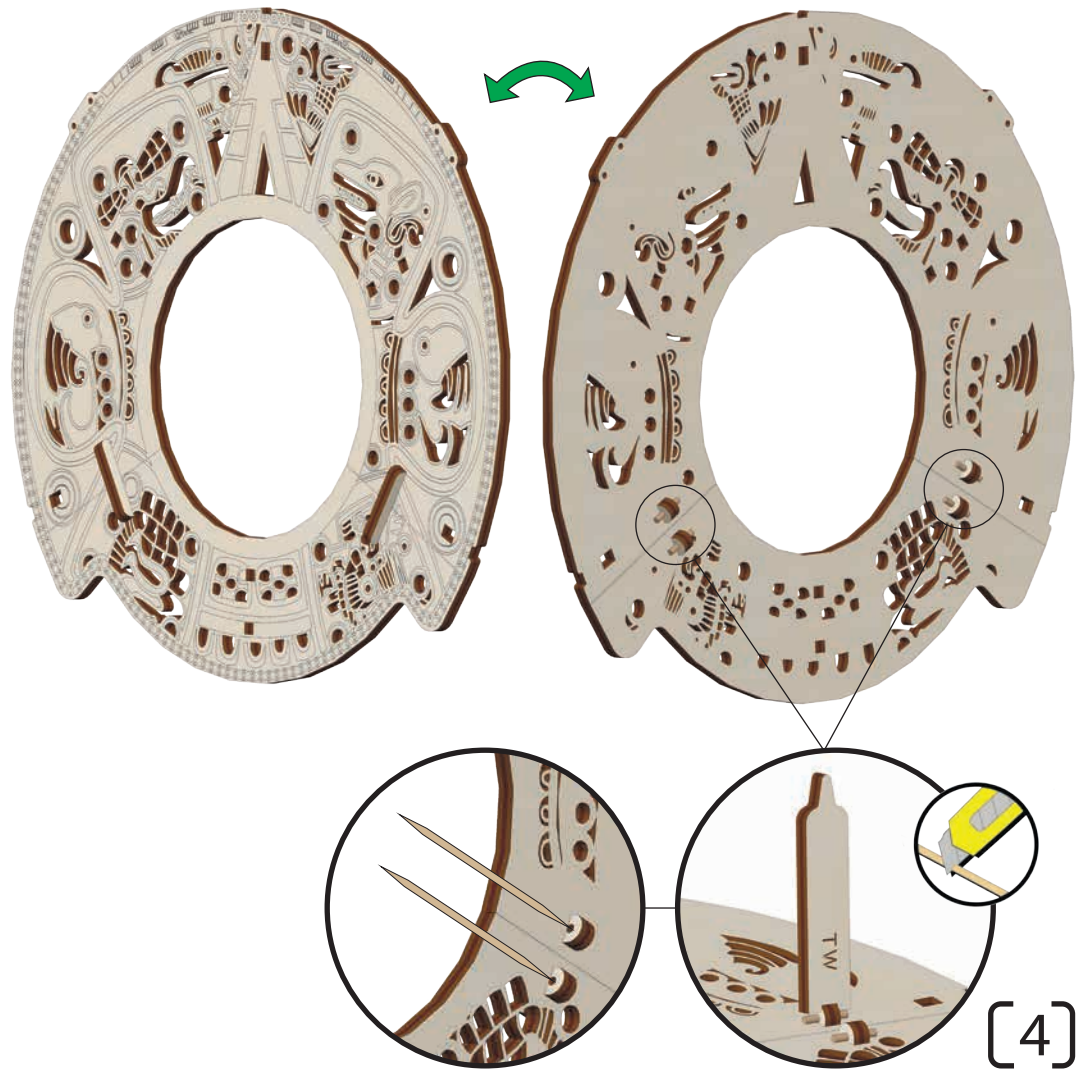
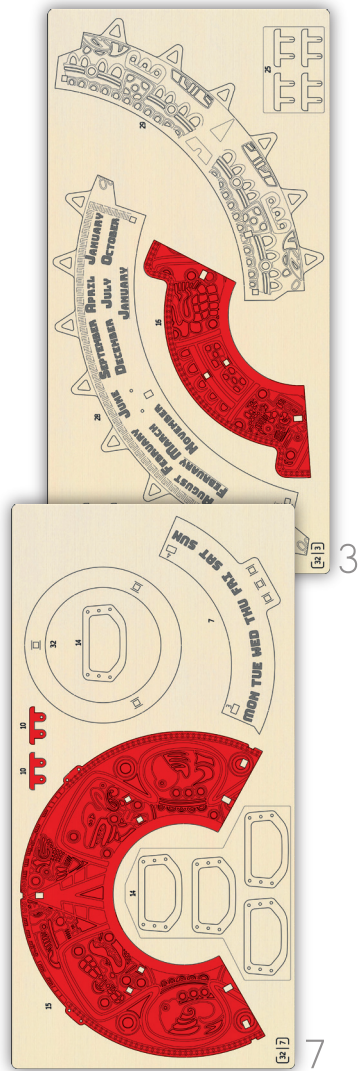

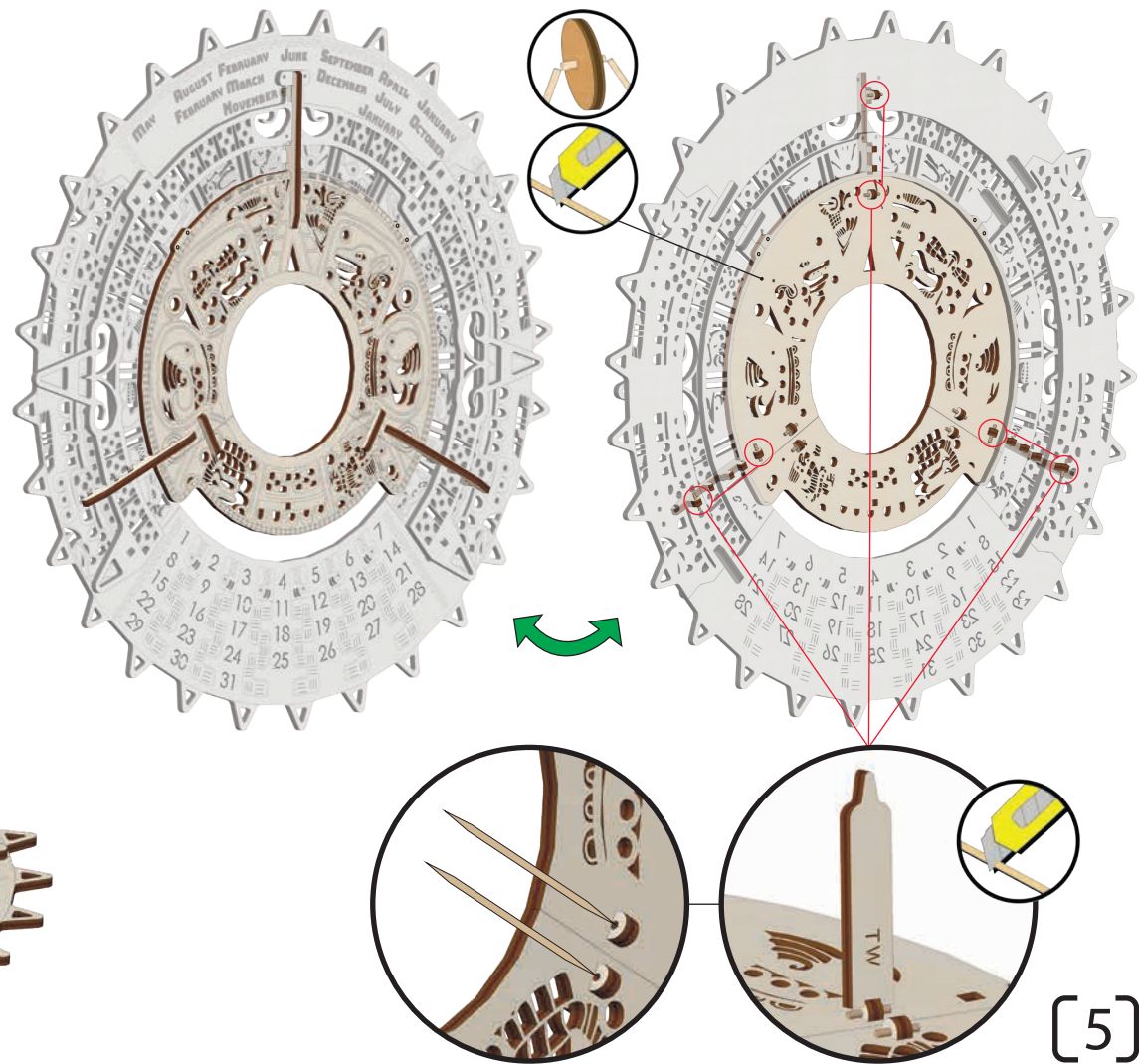
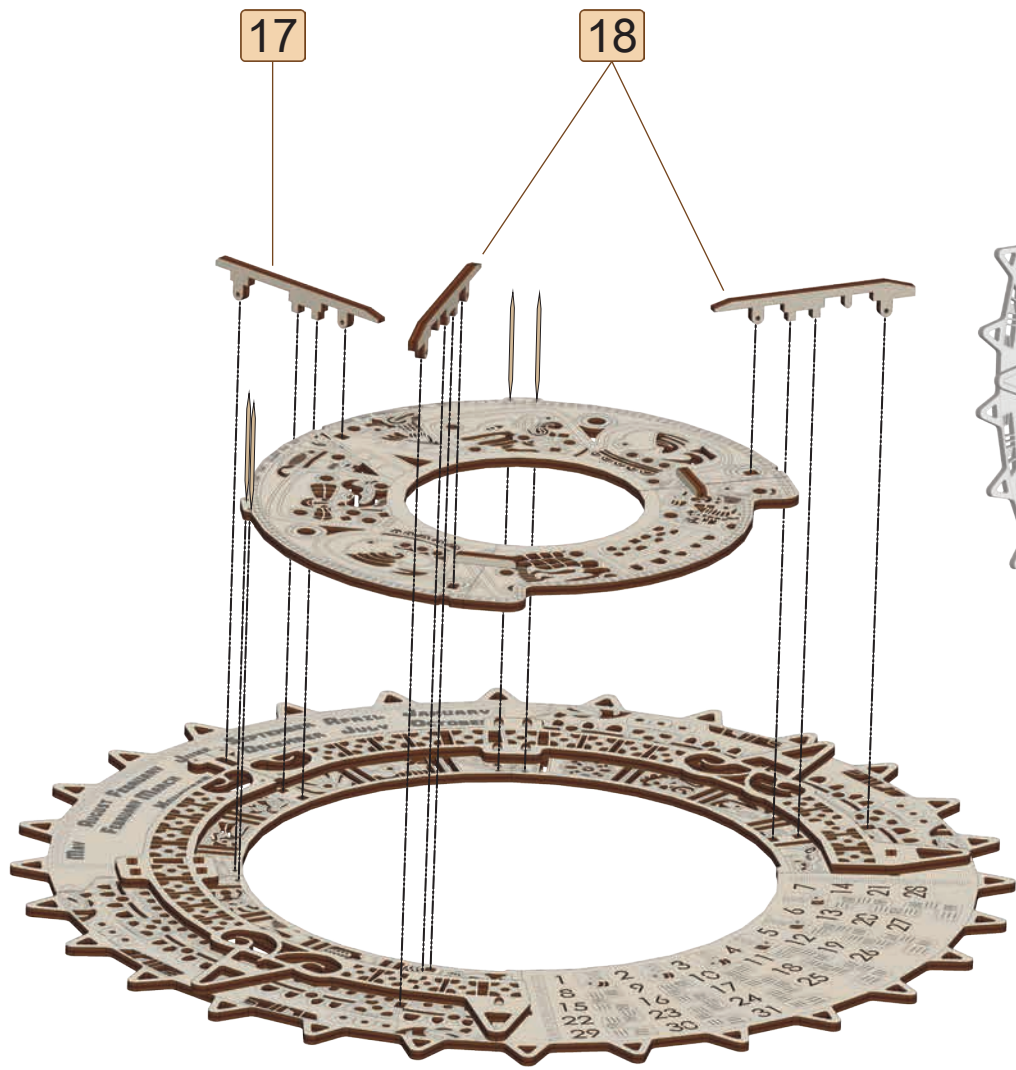
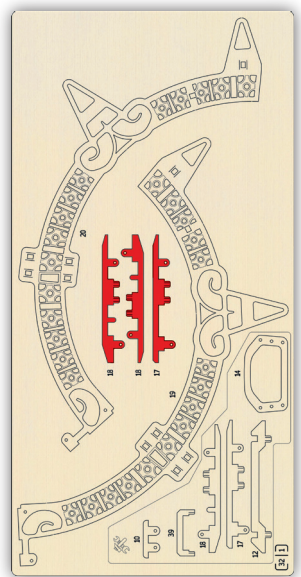

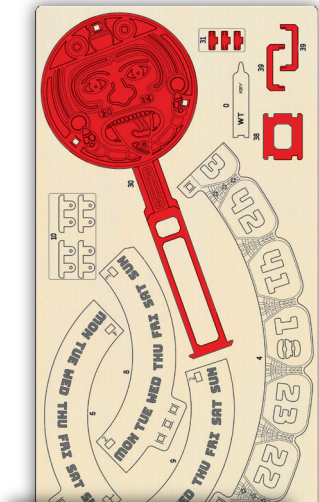

4

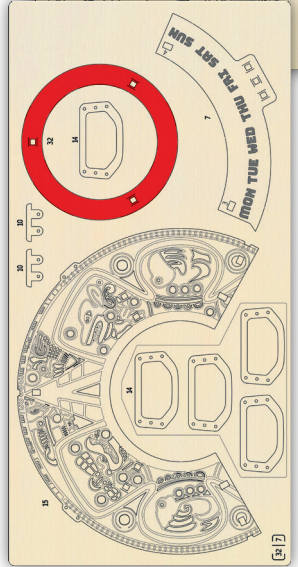

7

30

39

38



31

32

31



[6]

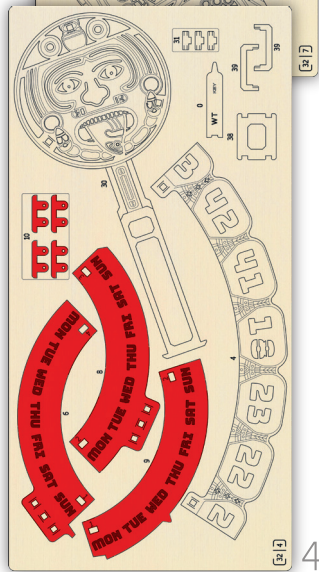
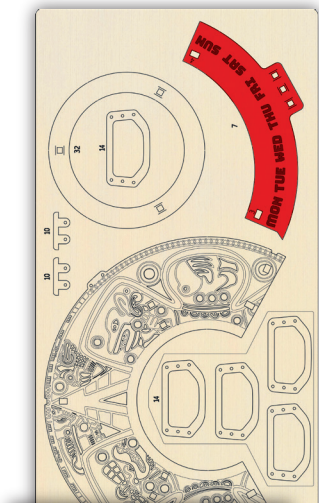

[7]

[4]

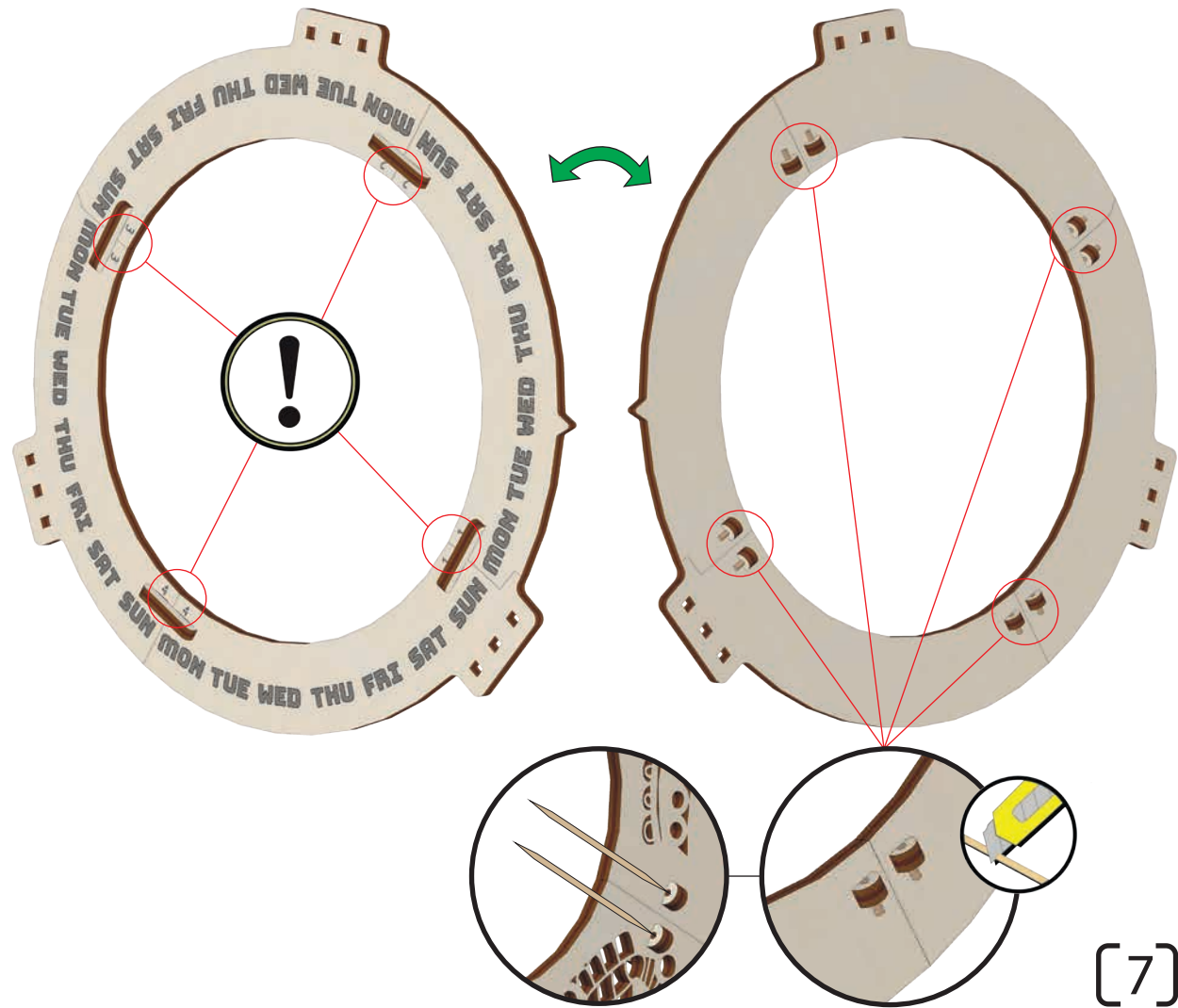
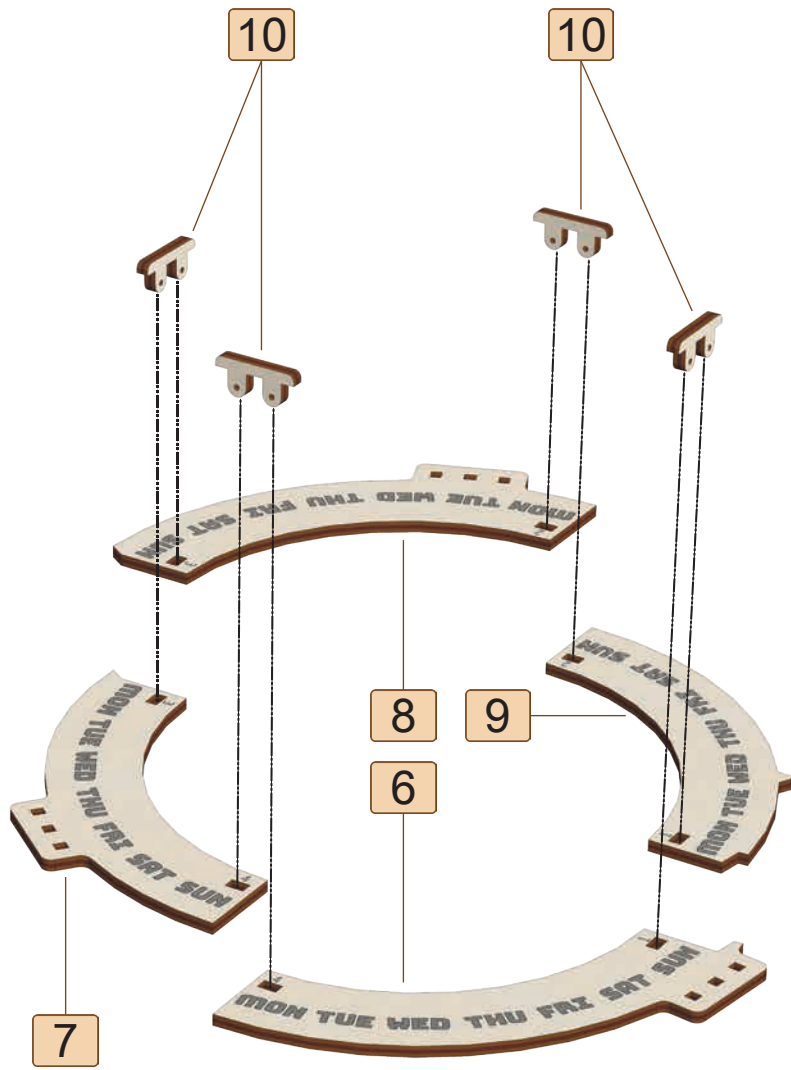

[7]

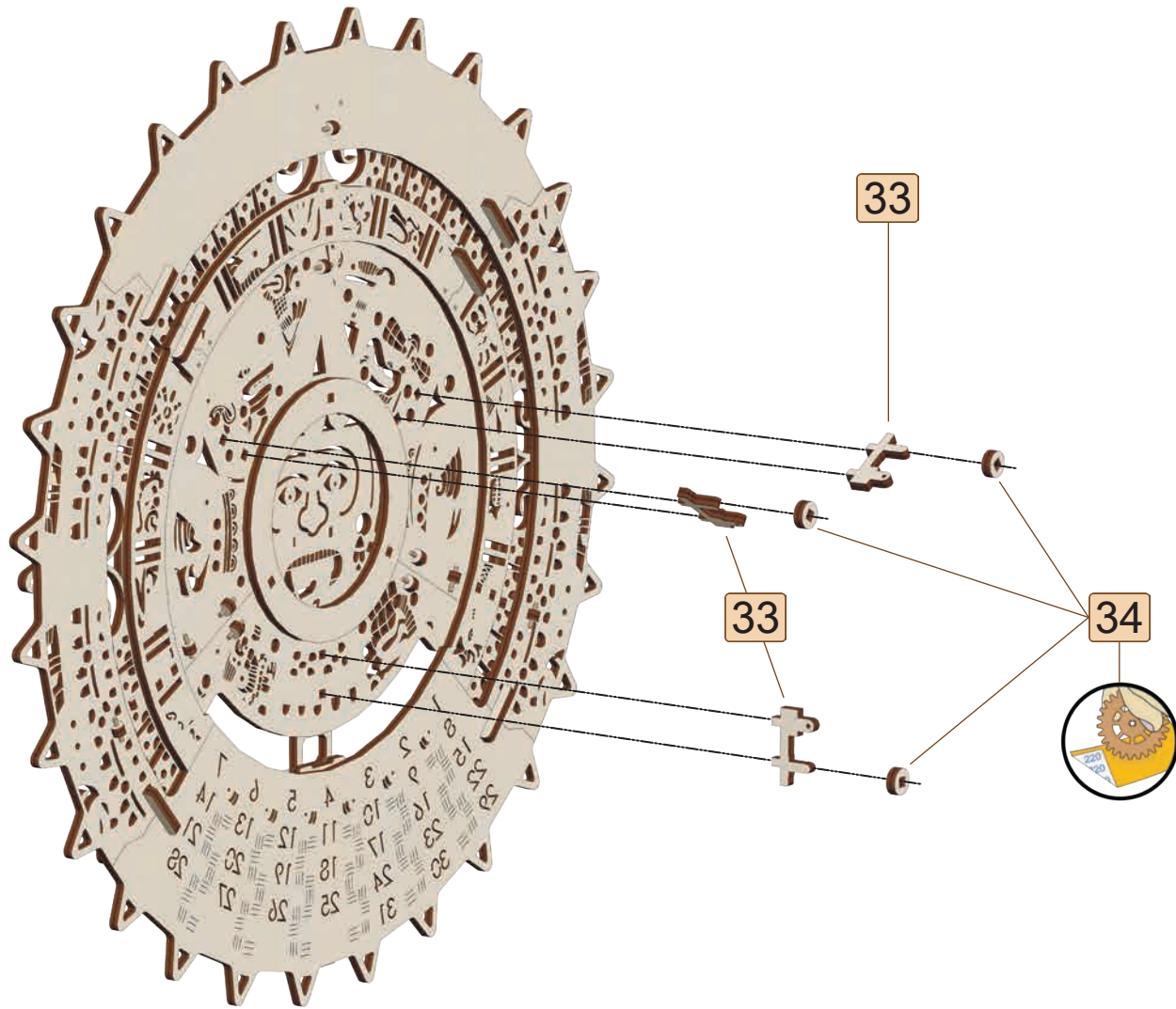
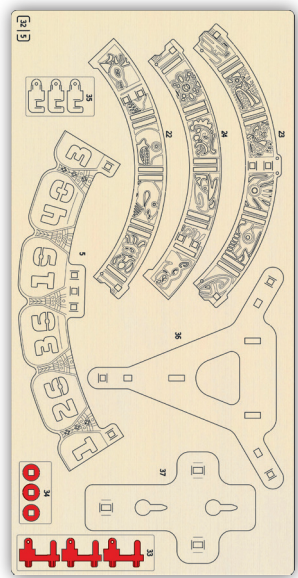

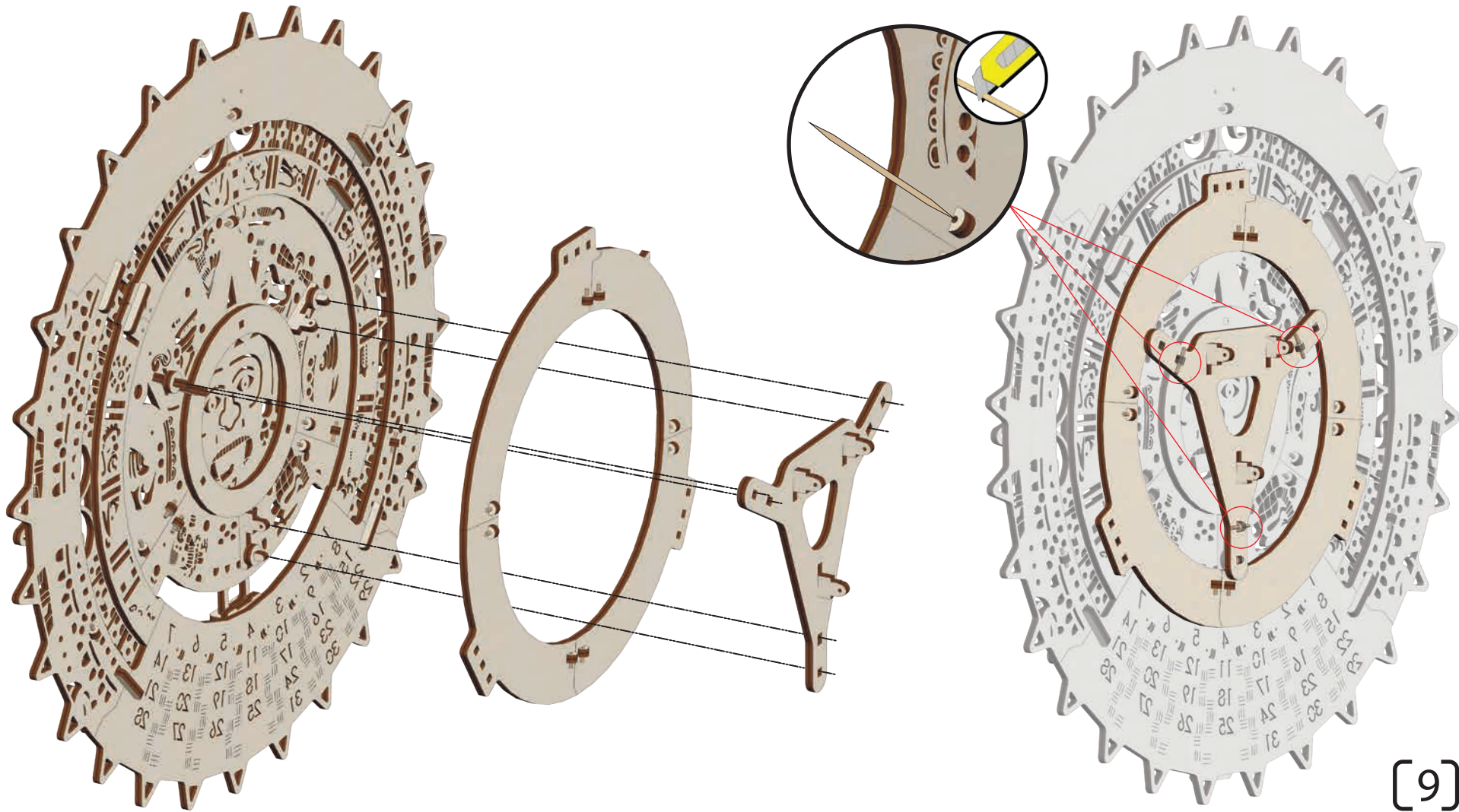
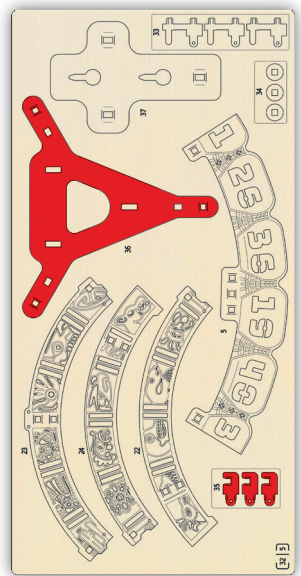
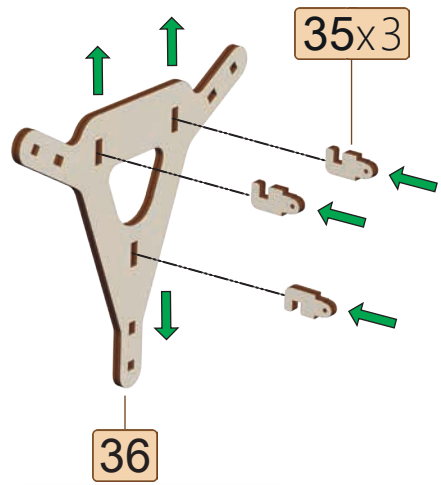

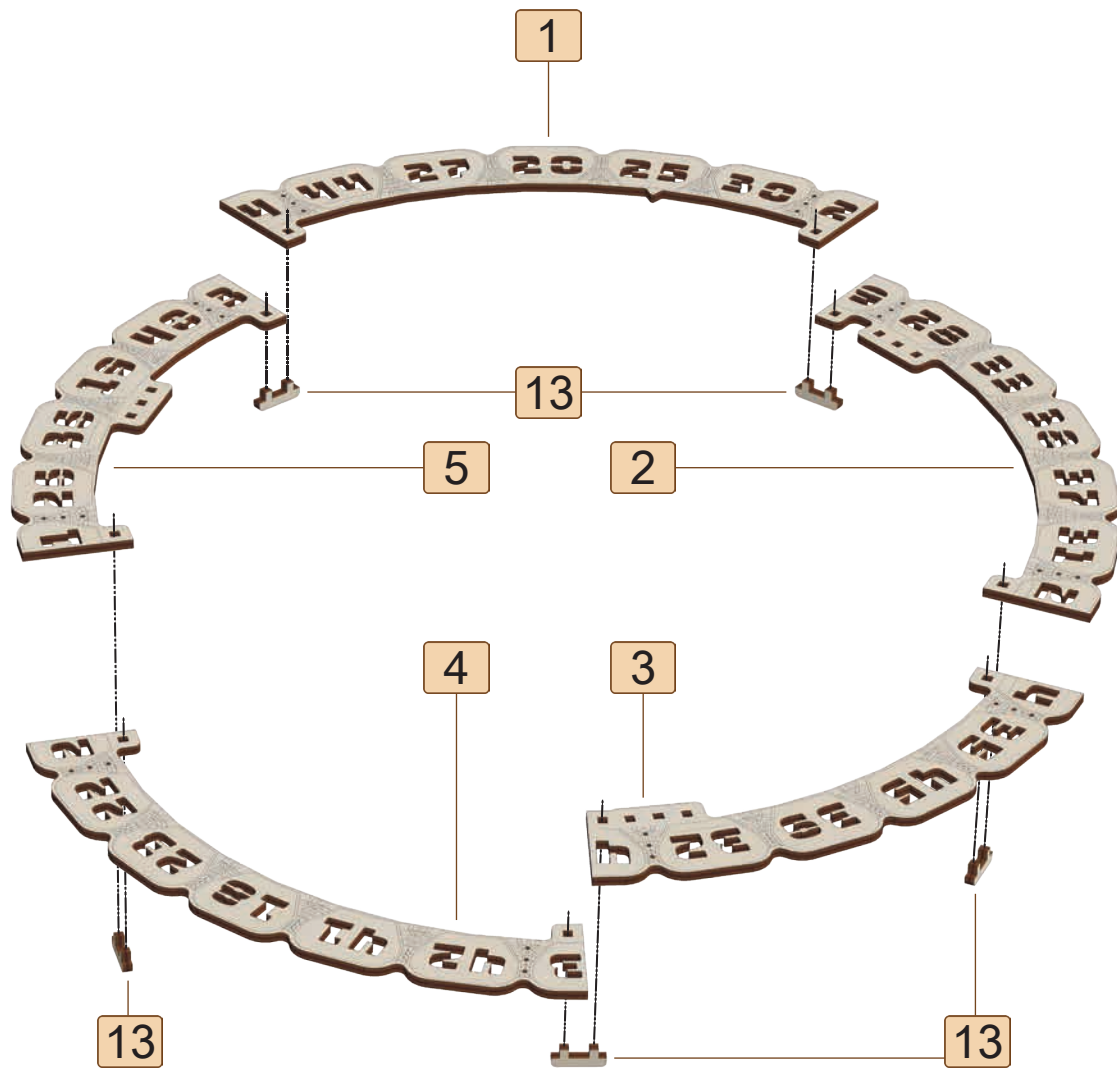
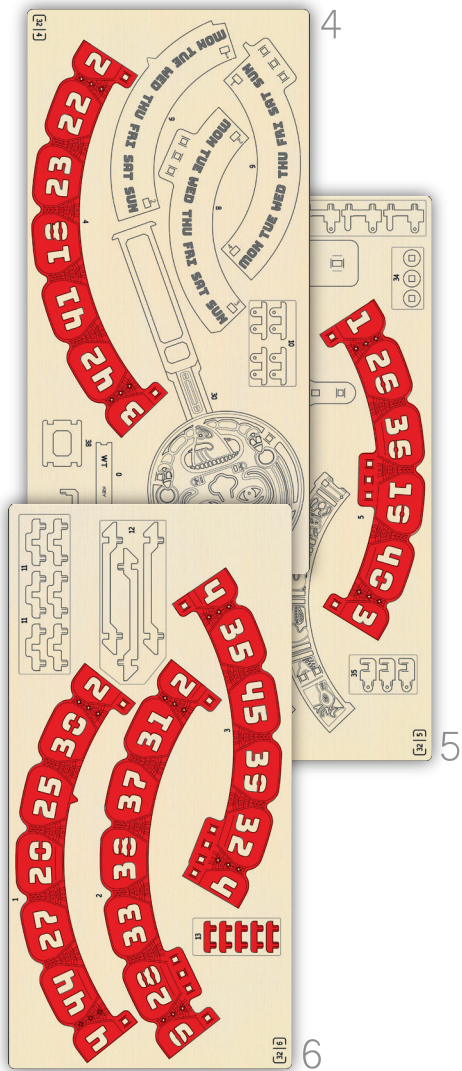

[10]

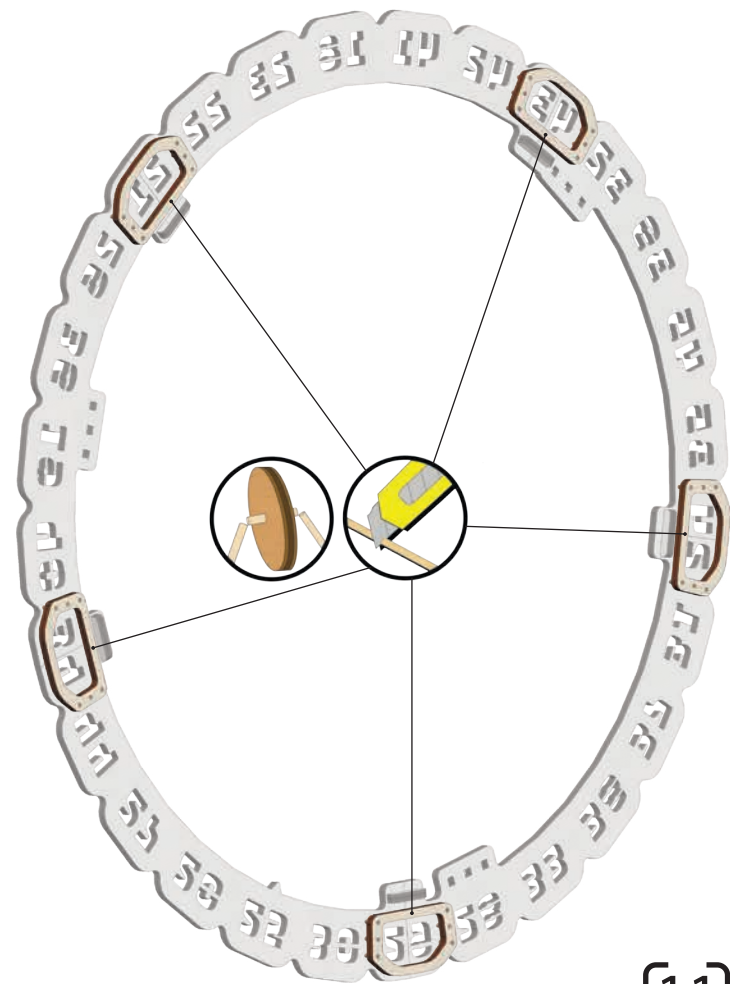
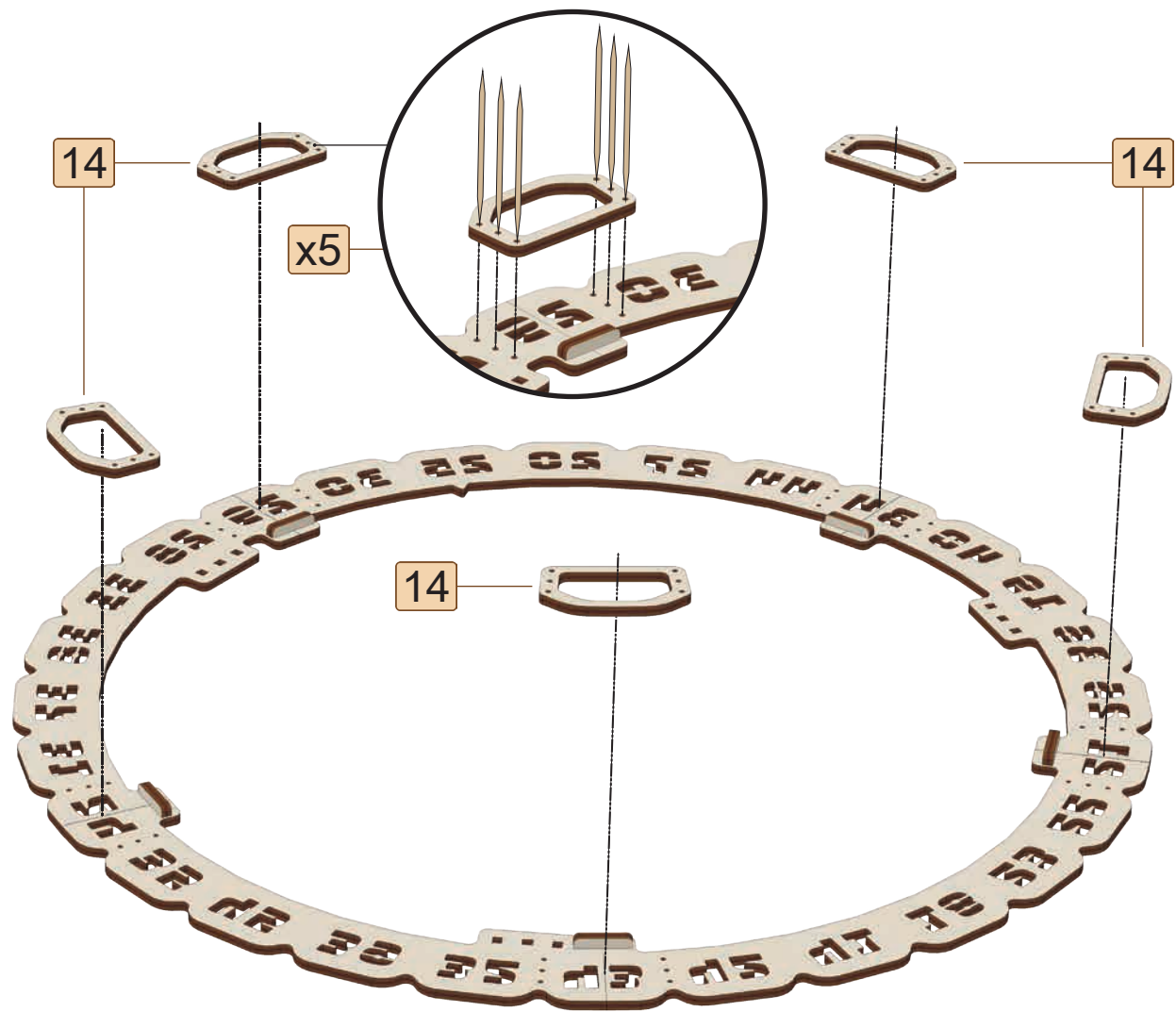
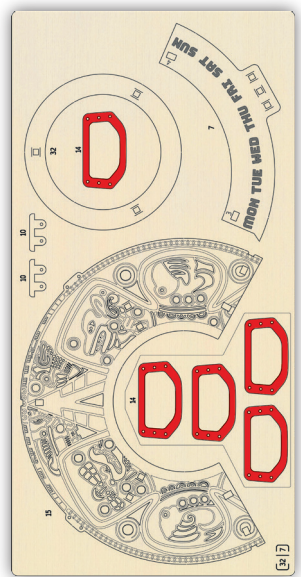

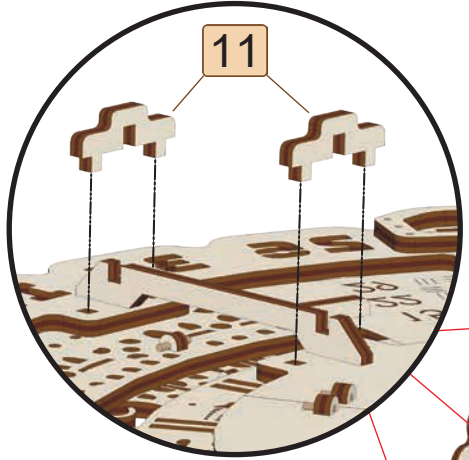
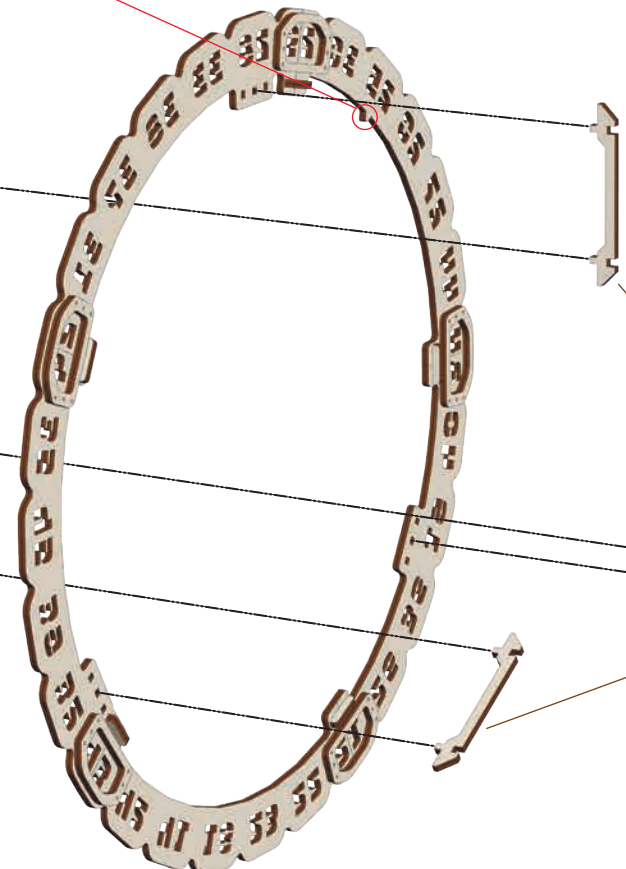
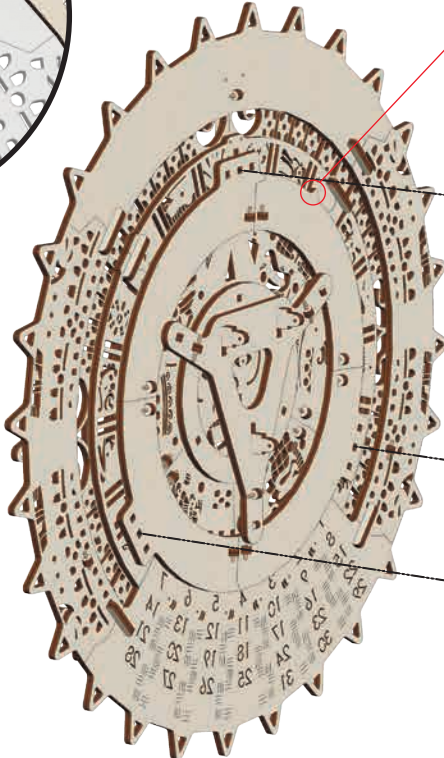
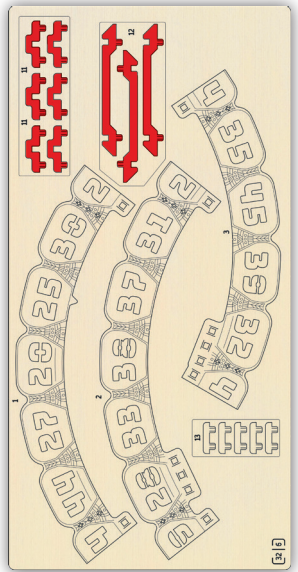
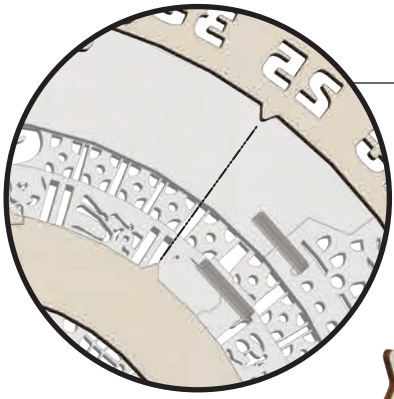

12

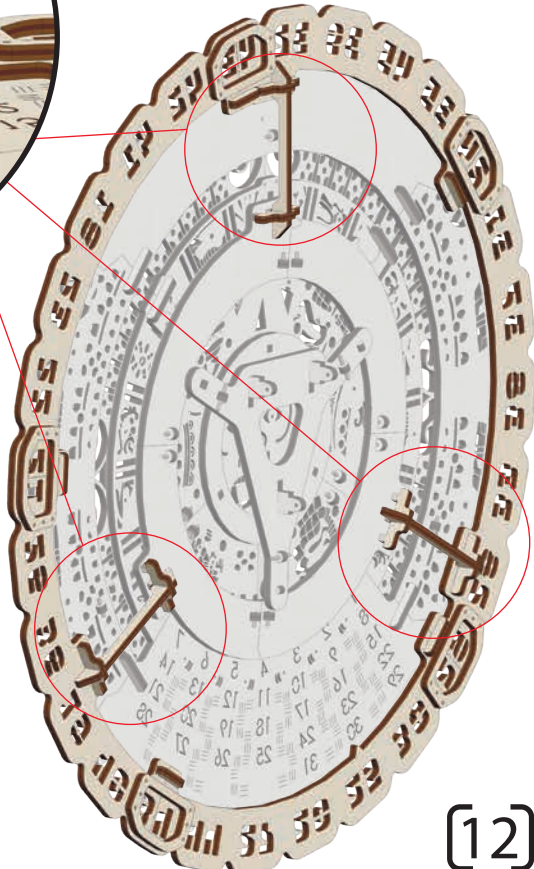

[12]

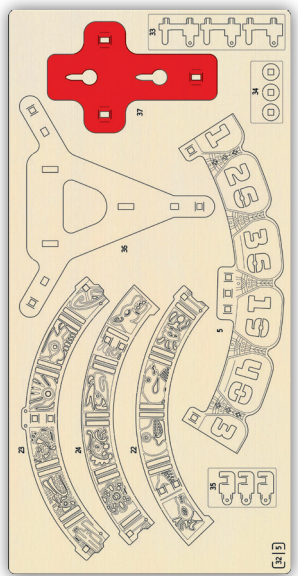

5

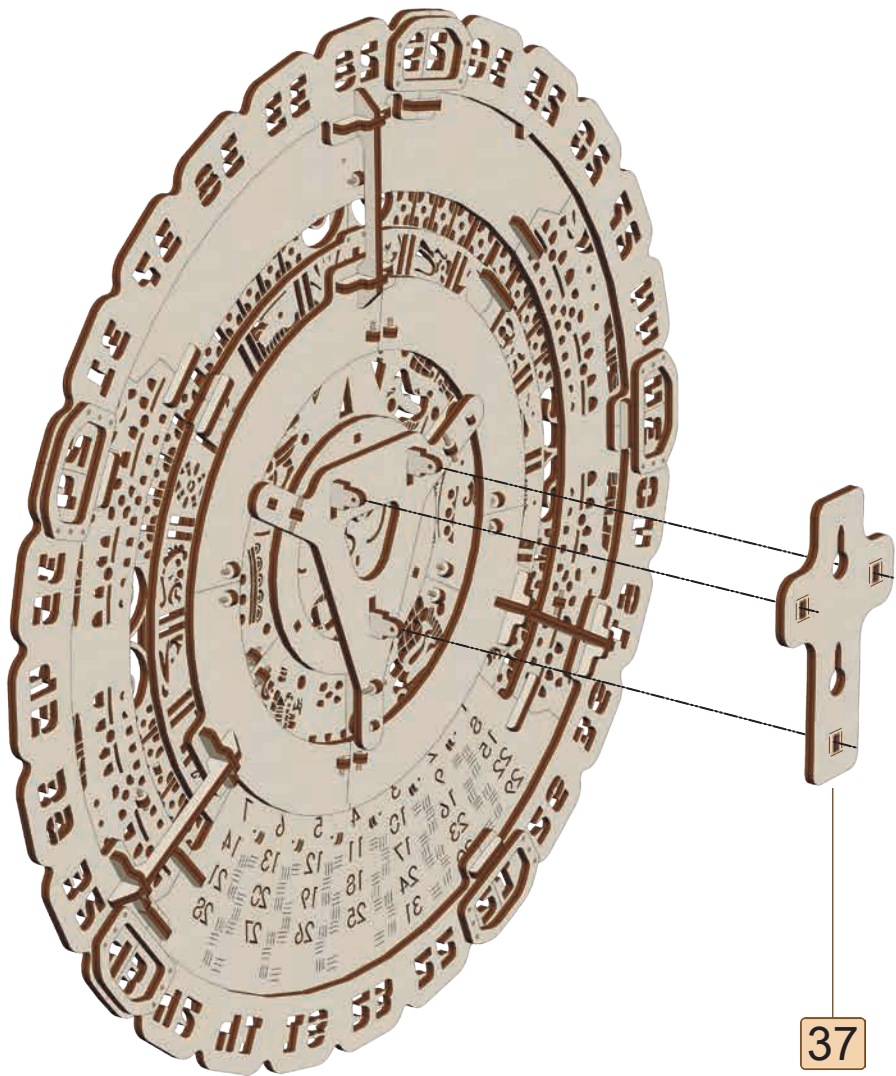

37

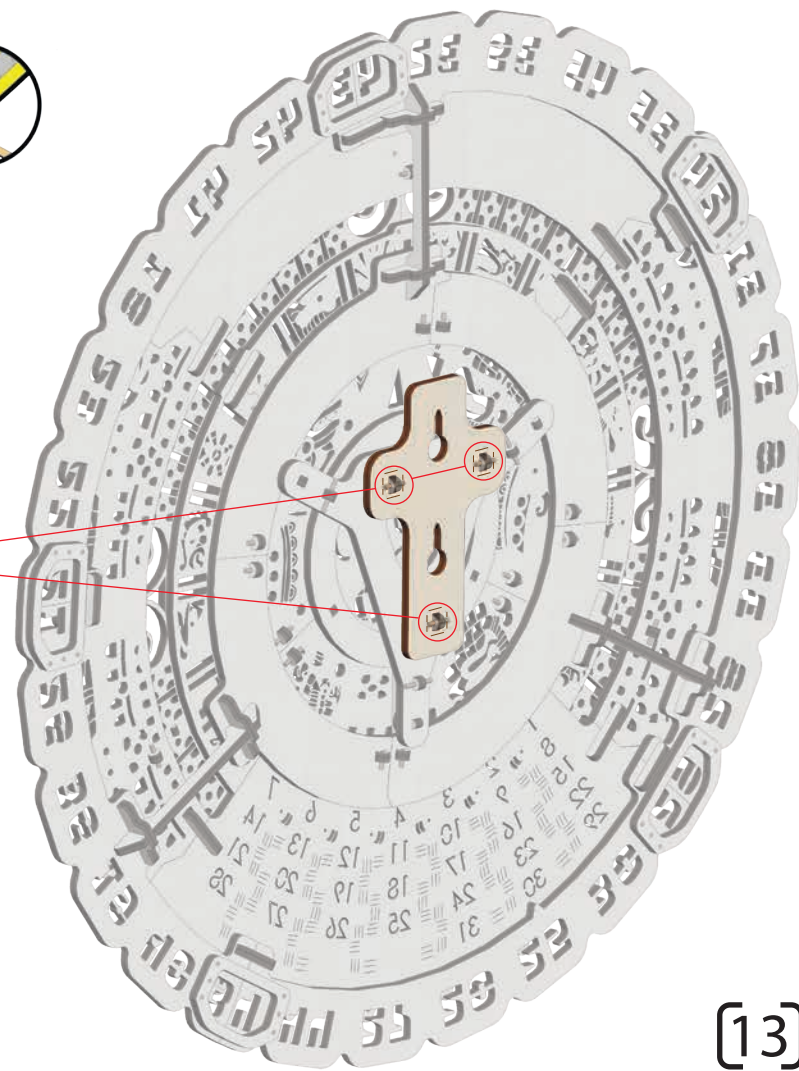
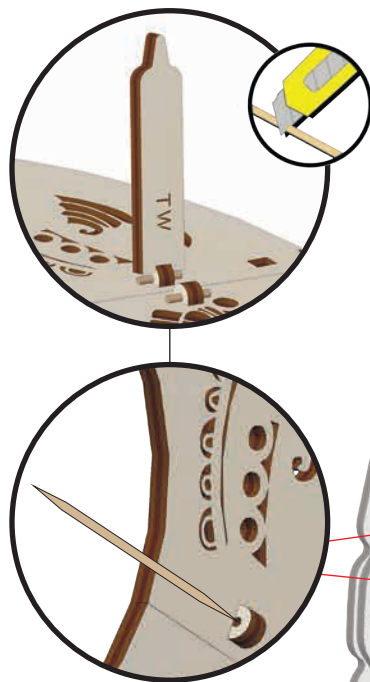

[13]

- RU** Сопоставить текущий год с текущим месяцем и выбрать день.
- UA** Сопоставити поточний рік з поточним місяцем і вибрати день.
- EN** To place a current year against a current month and select a day.
- GR** Das laufende Jahr mit dem laufenden Monat verbinden und den Tag wählen.
- ITL** Confrontare il mese e l'anno corrente e scegliere la data.
- FR** Superposer l'année courante et le mois courant et choisir le jour.
- ISP** Alinear el año corriente con el mes corriente y seleccionar el día.
- PL** Dopasować bieżący rok do bieżącego miesiąca i wybrać dzień.

- RU** День.
- UA** День.
- EN** Day.
- GR** Tag.
- ITL** Il giorno.
- FR** Le jour.
- ISP** El día.
- PL** Dzień.

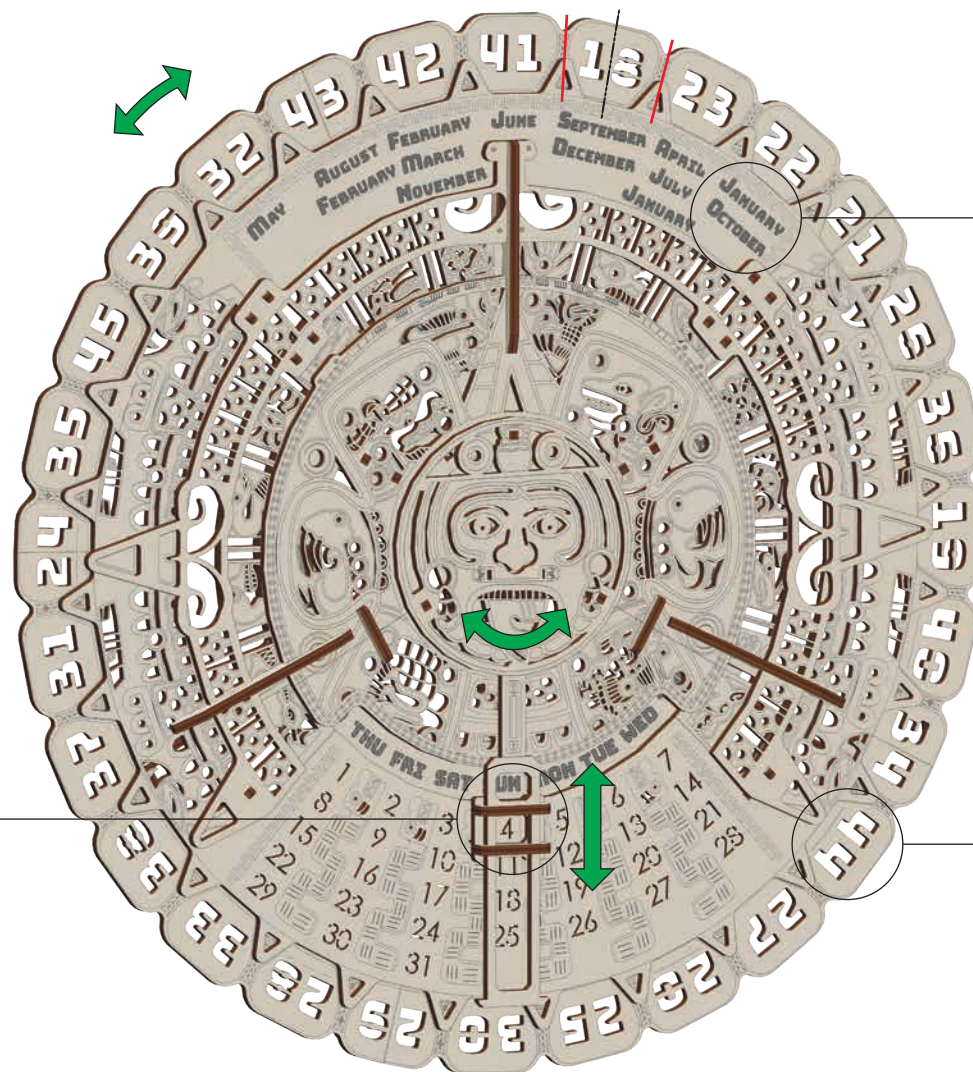

- RU** Месяц.
- UA** Місяць.
- EN** Month.
- GR** Monat.
- ITL** Mese.
- FR** Mois.
- ISP** Mes.
- PL** Miesiąc.

- RU** Год.
- UA** Рік.
- EN** Year.
- GR** Jahr.
- ITL** Anno.
- FR** Année.
- ISP** Año.
- PL** Rok.

