

# INSTRUCTION MANUAL

**THIS MODEL IS NOT A TOY!**

THESE INSTRUCTIONS SHOULD BE READ BY A SUPERVISING ADULT

## SUPER MONO X V2 2.4GHz RTR

ITEM NO. 8209

### CONTENTS OF SET

- 1) Super Mono X Racing Boat
- 2) Transmitter
- 3) Spare Nylon Propeller
- 4) Deans Plug W/Heat Shrinking Tube
- 5) Boat Stand
- 6) 2.5mm Allen Key (For Turn Fins)
- 7) Hook & Loop Strap

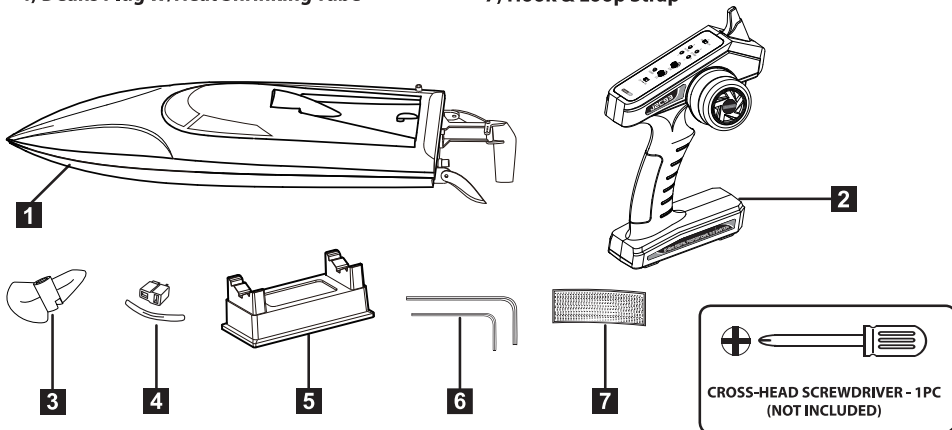

### Caution for LiPo battery:

ESC with low voltage hard cut off at 3.2V per cell, when driving your boat, as soon as you notice boat stop, that means ESC low voltage cut off effective, you should immediately drive boat back to shore in slow speed, recharge battery and race again. don't keep racing boat when ESC low voltage cut off effective, otherwise, you will allow battery over discharge, battery voltage will reach very low and won't be recharged again.

### ATTENTION:

Before racing your model boat, carefully check silicone tube for guarantee good water cooling system; Avoid water inlet on the bottom of hull become deformed, otherwise, water cooling system failure, this may lead to ESC burned out and motor defected.

### IMPORTANT

Super Mono X is designed for use in fresh water only. It is not designed for use in salt water! Super Mono X is not intended for persons under 14 years of age, unless closely supervised by an adult.

This model is capable of over 45 KPH, Personal injury or property damage may result from misuse of this product, take care and enjoy your model responsibly.

## BATTERY RECOMMENDATION

One pack of 11.1V 1800mAh 35C LiPo battery (Not included)

**NOTE:** If you have existing 11.1V Lipo battery pack, you can update them for use by changing the connector to Deans connector which is included in the kits bag, be sure to solder the connector to the battery in the proper polarity. (1 Male Deans connector is already soldered with the ESC, the other 1 Female Deans connector is included in the kits bag)

## CHARGER RECOMMENDATION

2S/3S Balance Charger and adapter, or multi-functional intelligent charger (Not included)

## INSTALLING TRANSMITTER BATTERIES

NOTE: The transmitter is not water resistant and should never come in contact with water.

1. Install four fresh "AA" batteries. Follow the diagram located in the bottom of the battery tray for proper battery orientation

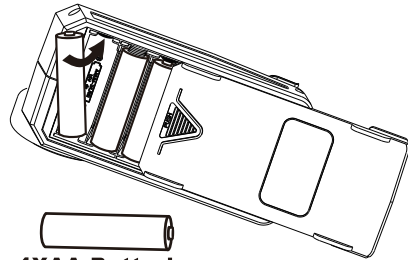

**4XAA Batteries  
(Not Included)**

2. Turn the transmitter "ON" The battery light should glow bright RED

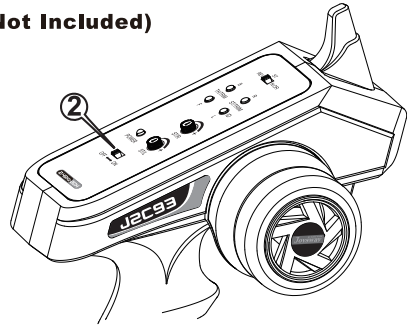

## RECEIVER CONNECTION DIAGRAM

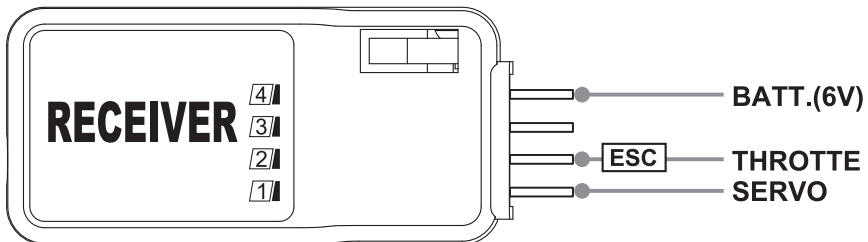

**Note: ESC with BEC function, no need to connect battery with receiver.**

## TRANSMITTER/RECEIVER BINDING

The binding process effectively ties the transmitter and receiver together. Under normal circumstances, both items are supplied like this from the factory. If, however, you find that your transmitter and receiver are not bound(receiver's red LED is on), you should do the following:

1. Switch "ON" the transmitter.
2. Switch "ON" the receiver by connecting battery to ESC, and ESC cord is plug into Receiver properly(Note:ESC has BEC function).
3. Press down the "BIND" button on the receiver, the receiver's green LED will be on to indicate that binding has been successful and the receiver will now accept commands from the transmitter.

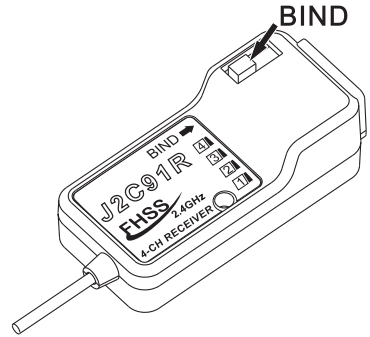

Note 1: During binding process, transmitter and receiver should be no more than one meter apart and no other similar devices should be within 10 meters.

Note 2: if the green light flashing, showing the binding failure, please do again as above indication.

## INSTALLING THE 11.1V LIPO IN THE SUPER MONO X

(Always turn on transmitter before connecting the battery with ESC)

1. Remove Super Mono X 's upper deck by rotate the plastic lock at its rear section.
2. Insert the 11.1V LiPo into the left side of the hull. Tie the power pack with provided hook and loop strap inside the hull.
3. Attach the 11.1V LiPo's connector to the matching connector in Super Mono X. Listen for three continuous "BE, BE, BE" (Signal noise of auto detected ESC)
4. Re-position the upper deck.

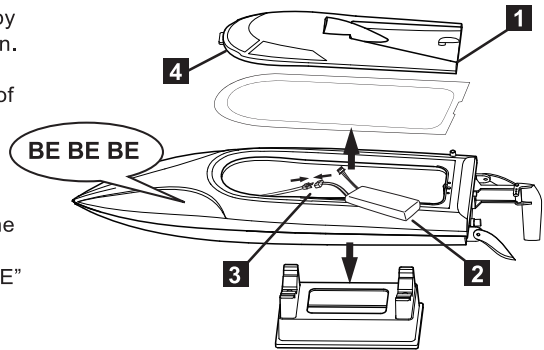

**NOTE:** 1. There is a water proof rubber ring placed along the slot of hull, always make sure it's secured positioned before re-position the upper deck.

2. It is suggested that don't leave the rubber ring in the slot of hull. Remove the rubber ring when not racing the boat, so as to keep the rubber ring flexible for water proof effective.

## CHECKING THE RADIO SYSTEM

1. Always turn the power "ON" to the transmitter before connecting the battery with the ESC.

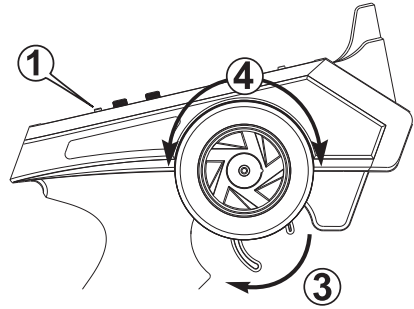

2. Plug the battery into the ESC plug and listen for three continuous >Be<>Be<>Be<.  
(Signal noise of auto detected ESC)

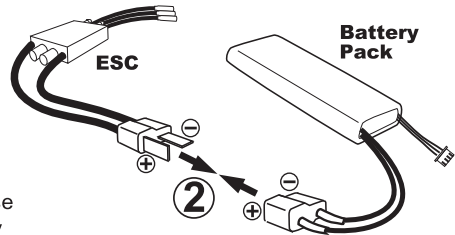

3. Pull the throttle & motor rotate in anticlockwise direction, your motor is now armed and ready for operation.

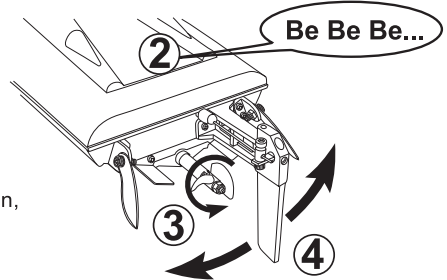

4. Check the direction of the rudder, the trailing edge of the rudder should turn right when right input is given, Conversely, when left input is given, the trailing edge of the rudder should turn left.

## WATERPROOFING TIPS

You should take steps to ensure that your model and its radio control equipment are adequately protected against the possibility of water damage. Place your model's receiver inside the included rubber bag (balloon) and tie the end off with a cable tie or similar.

Ensure the propeller's flexible shaft is properly lubricated (see below) as this too will reduce the possibility of water entering the hull during operation.

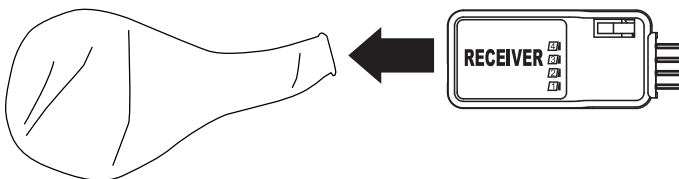



## TURN FINS

Super Mono X features adjustable turn fins to aid in turning. These can be adjusted using the included Allen key. The optimum angle of adjustment is 45 degrees to the hull.

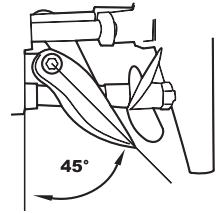

## DRIVING YOUR SUPER MONO X

1. Switch 'ON' the transmitter. Check that the transmitter's red LED glows brightly.
1. Check that Super Mono X 's turn fins are adjusted correctly.
3. Switch 'ON' Super Mono X (connect the 11.1V LiPo).
4. Check that the propeller and the rudder respond to transmitter inputs before placing Super Mono X on the water.

### AFTER USE

1. When you have finished using your Super Mono X, you should first switch 'OFF' the model (disconnect the 11.1V LiPo), then switch 'OFF' your transmitter.
2. Remove all batteries from the transmitter and model.
3. Leave Super Mono X 's upper deck off to allow moisture to evaporate. Ideally, place the model in this way in a warm and dry place, like an airing cupboard, until you are sure it is dry and then store it away.
4. Remove the rubber ring from the slot of hull, so as to keep the rubber ring flexible for water proof effective in next time boat racing.

**NOTE:** If Super Mono X begins to bob when running, it may have taken on an excessive amount of water. In this case, you should immediately return to shore, remove the upper deck and drain the water from the hull.

## TRANSMITTER INTRODUCTION

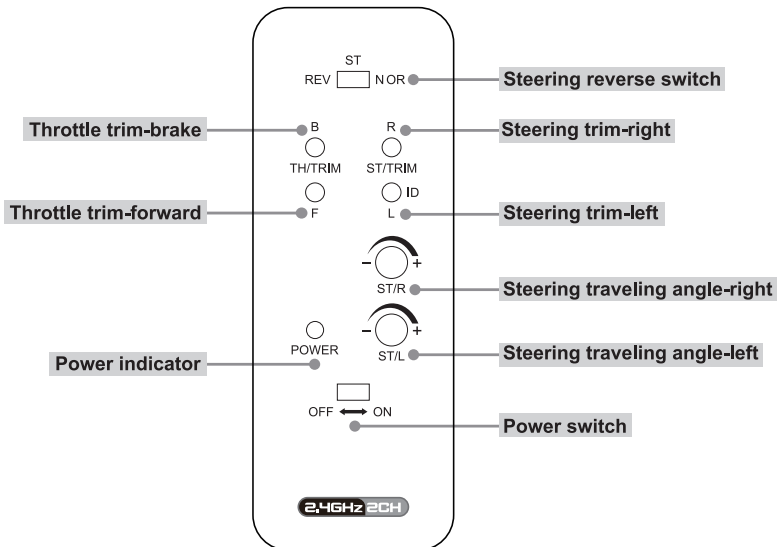

## EPA ADJUSTMENT

### Function

Use this when performing left and right steering angle adjustments. End Point Adjustment (EPA) adjusting value range: 0%-100%

### Setting

1. Steering (right side) angle adjustment Rotate "ST/R" knob to the left end point means minimum value 0%, right end point means maximum value 100%.
2. Steering (left side) angle adjustment Rotate "ST/L" knob to the left end point means minimum value 0%, right end point means maximum value 100%.

### CAUTION:

When adjusting this function, make sure the direction is in agreement with the boat direction, you can adjust by the STEERING "REV-NOR" button.

### Steering reverse switch

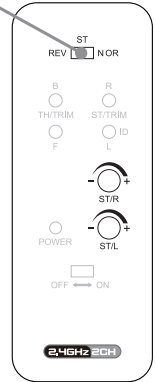
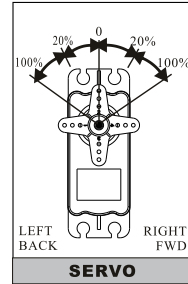

## TRIM ADJUSTMENT

### Steering trim

Adjust "ST/TRIM" "R/L" so that rudder is centered prior to operation, you may adjust this control to make the boat run straight during operation.

### CAUTION:

When adjusting steering trim, make sure the direction is in agreement with the boat direction, you can adjust by the STEERING "REV-NOR" button.

### Throttle trim

Adjust "TH/TRIM" "B/F" to stop propeller from turning while the throttle trigger is in the neutral position.

### Steering reverse switch

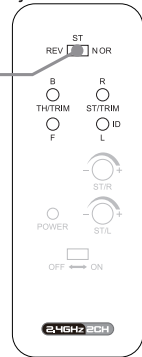

## LUBRICATING DRIVE SHAFT

Lubricating the flexshaft is vital to the life of the drivetrain. The lubricant also acts as a water seal, keeping water from entering the hull through the stuffing tube. Lubricating the flexshaft, propeller shaft after every 2 or 3 times of operation.

1. Use the 2mm Allen key to loose the two grub screws of the coupler which connects the flexshaft, then slide the flexshaft w/ prop shaft out of the stuffing tube.
2. Lubricate the flexshaft w/ prop shaft with the water proof marine grease, reinstall the flexshaft w/ prop shaft in reverse order, be sure to retighten the two grub screws of coupler.

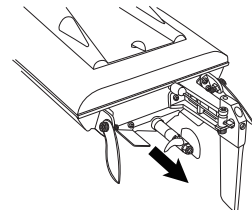
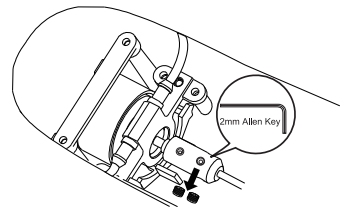

## IMPORTANT - Super Mono X

The bearing in the water cooled motor mount must be regularly lubricated with oil, grease or Vaseline petroleum jelly to prevent corrosion through the ingress of water.

Insufficient lubrication may lead to the premature failure of the bearing.

Note: Image shows drive shaft removed for clarity - the bearing can be lubricated with the drive shaft in situ.

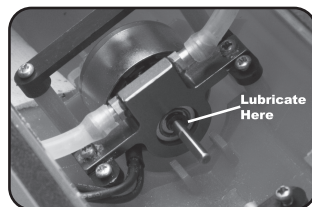

### CAUTION!

Please observe the following warnings.

#### DURING OPERATION

1. The transmitter's range will vary depending on your surroundings and battery strength. Do not operate Super Mono X too far away or control will be lost.
2. Ensure that all batteries are correctly installed and that the 11.1V LiPo is fully charged.
3. Do not operate your Super Mono X in areas with strong currents, in salt water or areas of water with large waves.
4. Do not touch moving parts during operation, especially the propeller.
5. Do not let your Super Mono X run aground, as this can cause damage.
6. If you lose control of your Super Mono X, never wade into deep water or water with strong currents to retrieve it. First, hold the transmitter as high as you can to try to re-establish control. If this does not work, find another way to move closer to the model, but do not endanger yourself in the process!

#### GENERAL INFORMATION FOR THE SAFE OPERATION OF YOUR SUPER MONO X

Please follow these simple rules to ensure safe operation and gain the maximum enjoyment from your model.

1. Avoid overloading your model. Never run it in areas where its movement will be restricted, e.g. areas where there is pond weed, etc., as this can over stress the motor.
2. Ensure nothing prevents the smooth running of moving parts.
3. Do not run your model in confined spaces.
4. Never run your model in a public space where it might upset or endanger people or wildlife.
5. Immediately switch 'OFF' your model and transmitter if you see lightning or hear thunder. Never use your model in the rain.

Do not dismantle or tamper in any way with this R/C vehicle and its transmitter. The manufacturer and distributor will accept no responsibility, expressed or implied, for accidents or injuries caused as a result of disassembly, modification and/or usage against the Instructions for this product.











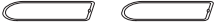

Tampering or modification will also invalidate the guarantee.

### TROUBLE SHOOTING

Check using the chart below before returning your Super Mono X for repair as many problems can be easily solved

PROBLEM	CAUSE	REMEDY
Model will not move	No battery in transmitter/model Battery installation is incorrect Weak battery in transmitter Weak batteries in model	Install batteries Install batteries correctly Install a fresh battery Recharge 11.1V LiPo
No control of model	Weak battery in transmitter	Install a fresh battery
Limited radio range	Weak battery in transmitter	Install a fresh battery

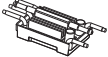
## SPARE PARTS

PART NO	DESCRIPTION	PHOTO
82030	Super Mono X deck	
82031	water proof rubber ring (PK2)	
82032	CF2812 out-runner brushless motor	
82033	water cooling mount for CF2812 motor	
82034	Coupler for CF2812 motor	
82036	9g rudder servo	
82037	Connected rod of Rudder	
82038	Rudder and support set	
82039	Trim tab set	
82004A	Flex shaft set	
82007	Stainless Steel Turn Fins Set	
93011	P1.4X30mm Two Blade Nylon Propeller(PK2)	
820902	30A Water Cooling Brushless ESC w/ BEC	
930518	J2C93 2.4GHz 2CH Transmitter	
930519	J2C91R 2.4GHz 4CH Receiver	



FCC WARNING: Changes or modifications not expressly approved by the party responsible for compliance could avoid the user's authority to operate the equipment.